

Fig. 3

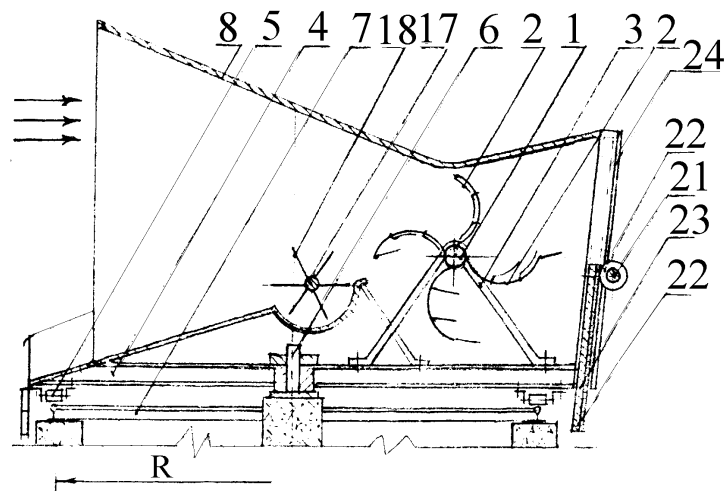

Fig. 4

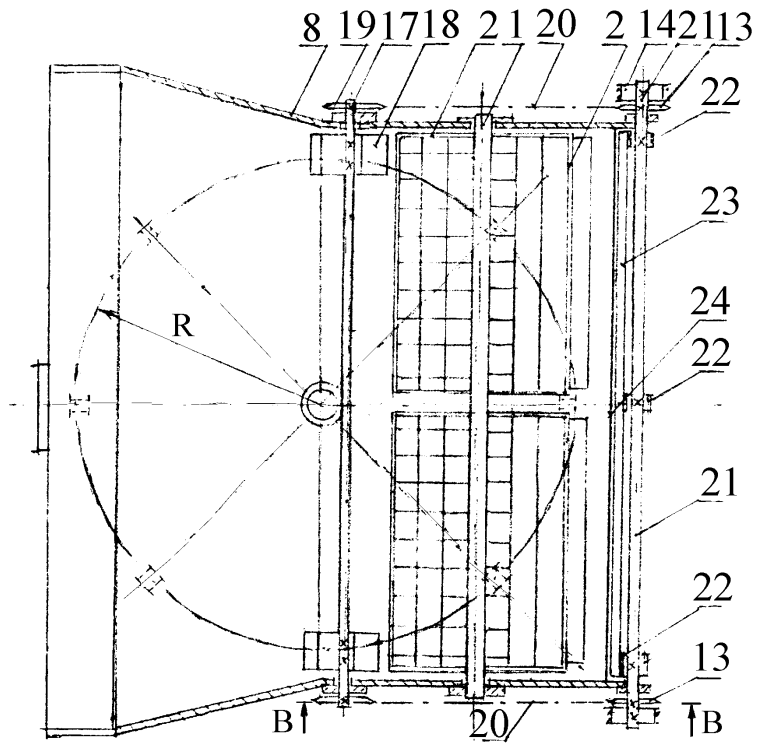

Fig. 5

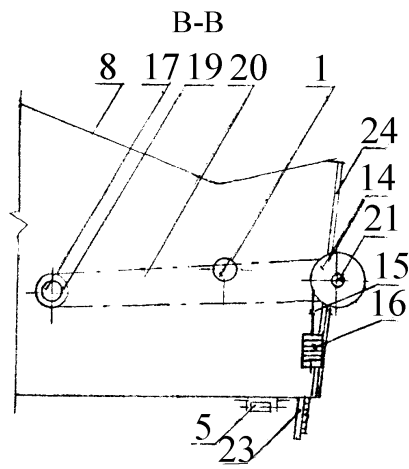

Fig. 6